

LED AC Motor Smart Soft Starter

Manual



Directory

1. Function and Feature	5
2. Product Type and Inspection.....	6
3. Environment and Installation.....	7
3.1 Environment.....	7
3.2 Installation.....	8
4. Operating Principle.....	9
5. Terminals and Wiring.....	10
5.1 Wiring Diagram.....	10
5.2 External Terminal.....	11
5.3 Main Circuit Wiring.....	12
5.4 Control Circuit Wiring	12
6. Control Mode	13
6.1 Voltage Ramp.....	13
6.2 Current Limit.....	13
6.3 Jogging	14
6.4 Stopping	14
7. Operating keyboard.....	15
7.1 Keyboard Description.....	15
7.2 Key Function.....	15
8. Parameter Table.....	16
9. Parameter Settings.....	18
10. Special Parameter.....	19
11. Display Current Calibration.....	20
12. Parameter Details.....	21
13. Working State.....	24
14. Fault.....	25
14.1 Fault Display and Solutions.....	25
14.2 Overload	26
15. Test running.....	27

Appendix1: Specification and Type	28
Appendix2: SS-xxA Series Structure Size (Built-in bypass contactor)	29
Appendix3: SS-xxN Series Structure Size (bypass up)	30
Appendix4: Keyboard Shape and Dimension.....	31
Appendix5: SS-xxN-G Series Structure Size (bypass up)	31
Appendix6: SS-xxN Series Typical Wiring Diagram.	32
Appendix7: SS-xxA Series Typical Wiring Diagram	33
Appendix8: SS-xxN-G Series Typical Wiring Diagram.....	34

Manual File Number: SS-xxN/SS-xxA-V2.3.2

Version Number: V2.3

Revision Number: 214

Issuance Date: 2014-10-18

1. Overview

This manual is applicable to SS-xxN/SS-xxA series products.

This manual is intended to guide qualified personnel in the installation and operation of this product.

In the case of a registered trademark and business ownership, final interpretation right to this manual is belonged to ABC VFD .Co LTD. Any unreasonable application, especially in reproduction and release by the third parties, is not allowed

Although the information in this manual is checked carefully, but there may be some mistakes. If you find them, please phone us as soon as possible.

Because this product is improved continuously, so user should regard this manual as the reference.

The parameters in the manual is only used to describe the product, In order to meet the needs of the customers, we will improving our products continuously to meet the latest technical criteria.

2. Safety



Pay attention to the note, warning and tips mentioned in this manual.

Only professional technician can be permitted to install or guide the installation of this product.

Ensuring the power and specification of the motor is matched to those of this product;

The capacitor is prohibited strictly to be connected with the output terminal (U.V.W) of this production

The cables connecting to the input and output terminals of this product should be packed well By insulating tape;

The shell of this product must be connected to the ground reliably;

Make sure the power of this product must be cut off before it is maintained.

This manual is packed with the product. Operator must take it as the guide of this product.

Please read it carefully before using this product.

3. Safety Mark

Attention, Warning and Notes

- ◆ Attention Something can lead to personal injury or death
- ◆ Warning Something can lead to damage of the device or software.
- ◆ Note Remind user something related.

1. Function and Feature

SS-xxN/SS-xxA series LED AC motor soft starter is new type starting equipment with advanced international level. This equipment designed and manufactured by the technique of power electronics microprocessor and modern control theory. This equipment can limit the start current efficiently when the asynchronous motor starts. It is widely applied in the field such as winding machine, pump, transition and compressor etc. It is the ideal product to replace the traditional voltage dropping start equipment such as star/triangle conversion, self-coupling voltage dropping, magnetic control dropping voltage etc.

Function

- ◆ Reduce the starting current of motor; reduce capacity of power distribution; reduce the investment cost;
- ◆ Reduce the start stress; prolong the operation lifetime of the motor and correspond equipment;
- ◆ Smooth and steady starting and soft stopping; The Water hammer and surge can be avoid;
- ◆ Several sorts of starting mode, wide range setting of the current and voltage. It can be used in a lot of load conditions, so the technic can be improved;
- ◆ Perfect and reliable protection; The safeguard of the motor and relative equipment can be achieved effectively;
- ◆ It can be used in the state in which motor should star and stop frequently.

Feature

- ◆ Starting Mode: Based on the load characteristics, different starting mode can the related parameters can be selected. So the best starting effect can be gained;
- ◆ Technical Performance: The higher performance microprocessor and software are used, so the Control circuit is simplified. The best perform speed can gained without the adjustment of the circuit parameters;
- ◆ Reliability: All the electronic components of this product are selected strictly. Additionally, the main control board is tested in high temperature environment above seventy-two hours. The reliability of this product can be guaranteed
- ◆ Structure: The modularization structure and up-in-down-out wiring mode are adopted. It is easy to used and integrated;
- ◆ Multi-Protection: The motor protection circuit is not be added if the single product is in used. Because of this product have multiple protection functions (Such as over-current, overload, phase-fault, overheat and so on). So the cost can be reduced, the circuit can be simplified.
- ◆ Keyboard: Operation of the keyboard is easy. User can set and modify the parameters (for example: starting, stopping, running, protection) by this keyboard according to different load

conditions.

- ◆ Analog signal output: 4-20mA analog sign output 1 is provided;
- ◆ RS485 通讯: provide RS485 (Modbus communication protocol) communication;
- ◆ Actual power setting: When the rate power of Soft Starter is higher than the power of actual load, soft starter can be matched to the actual load by modifying the actual current parameter. So the parameters about starting, running and protection are correct

2. Product Type and Inspection

Each SS-xxN/SS-xxA series soft starter is tested. Only the starter that passes the function and running test can leave the factory. After receiving the equipment, the user should inspect it according the steps described below. Please notify the supplier immediately if you find any problem

- ◆ Check the nameplate: Check the item(s) nameplate catalog number against the purchase order. Make sure that the equipment you received is matched with the product you ordered.

SS-xxN/SS-xxA Series motor soft starter Type: _____ Motor Power: Rated _____ KW Current: Factory _____ A Number: _____ ABC VFD Co., Ltd
--

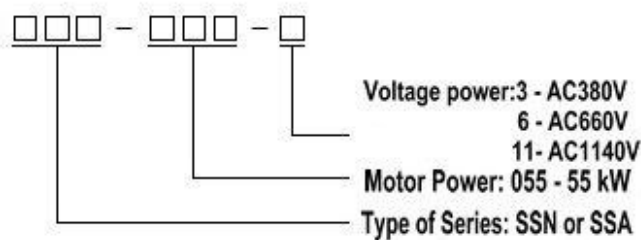

- ◆ Inspect whether or not the product is damaged through the delivery, for example: Inner parts fall off, Shell is deformed or depressed, the wires is loose etc.
- ◆ Quality certificate and user manual: The package of each soft start includes quality certificate and user manual

3. Environment and Installation

3.1 Environment

The environment is important to the equipment life. So please install the soft starter on the site described below

◆ Operation Condition for the standard products

Power Supply: Urban power, self-provided substation, diesel generating sets

Three-phase AC: 380V or 660V or 1140V (-10%, +15%), 50Hz.

(note: voltage level should be matched to the rate voltage of the actually motor, user should explain the voltage level in the purchase order if it is special.)

Motor: Squirrel cage asynchronous motor. (Please explain in the purchase order if it is special)

Start frequency: less than 20 times per hour for Standard products (Please explain in the purchase order if the motor should be start more frequent)

Cooling: Natural air-cooled or Fan air cooling

IP Code: IP20

Environment condition: If the altitude is above 2000 M, user should select the higher power product.

Environment Temperature: -25°C to +40°C.

Relative humidity: $\leq 95\%$ ($20^{\circ}\text{C} \pm 5^{\circ}\text{C}$) non-condensing, no inflammable, explosive gases, no conducive dust.

Install in an enclosure with good ventilation. The vibration is less than 0.5G

Structure Form: For the SS-xxN series product, bypass contactor should be allocated by user

For the SS-xxA series product, there is inner bypass contactor

◆ Special conditions

If unconventional products using in the special conditions is needed, please explain in the purchase order

3.2 Installation

◆ Direction and Distance

The product must be vertically installed. There should be enough space to dissipate the heat, as shown in figure 3-1. For the cabinet product, there should be a certain distance between back door of the product and wall. Therefore it is easy to maintain.

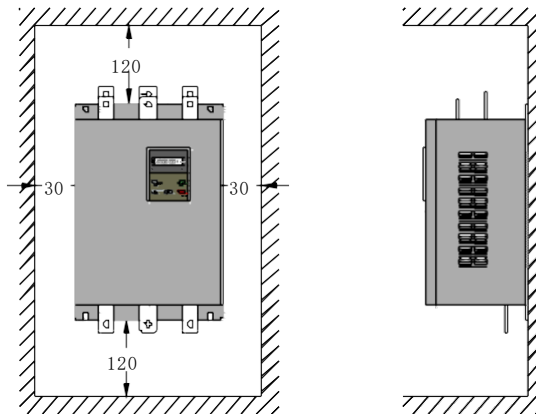

Figure 3-1

◆ Cabinet installation

If the product is installed in the cabinet, make sure there are good ventilation in the cabinet. The products can be installed vertically or horizontally. Horizontal layout shows in Figure 3-2. Vertical layout shows in Figure 3-3. User can adopt any of them.

Note: If the vertical layout is adopted (especial in fan air cooling mode), clapboard should be installed between them to avoid that the upper starter is affected by heat generated by the lower starter.

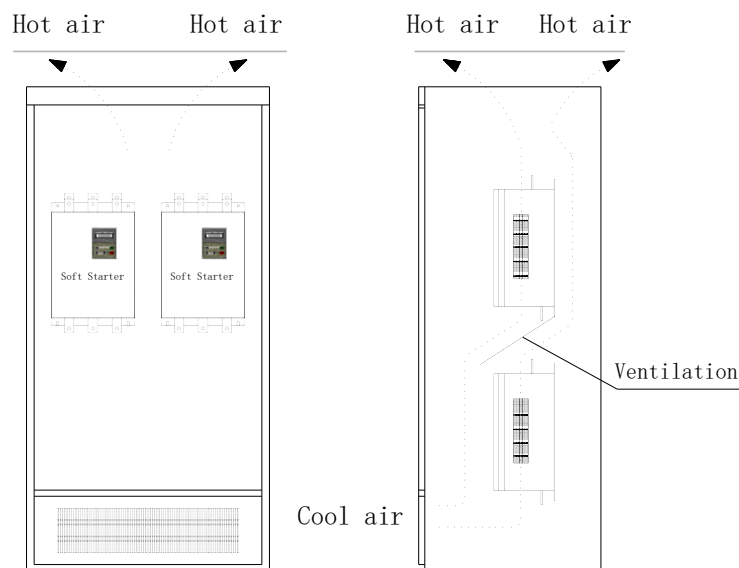

Figure3-2
Horizontal layout

Figure3-3
Vertical layout

4. Operating principle

There are three pairs of anti-parallel thyristors connected to the stator of motor. Using the electric switch feature of the thyristors, the voltage of the motor can be controlled by changing the triggering angel of the thyristors. The triggering angel of the thyristors is controlled by microprocessor. So the motor can be started softer and smooth. After the equipment is up to full voltage, it outputs a bypass signal. User can use this signal to control the bypass contactor to supply the motor. See figure4-1.

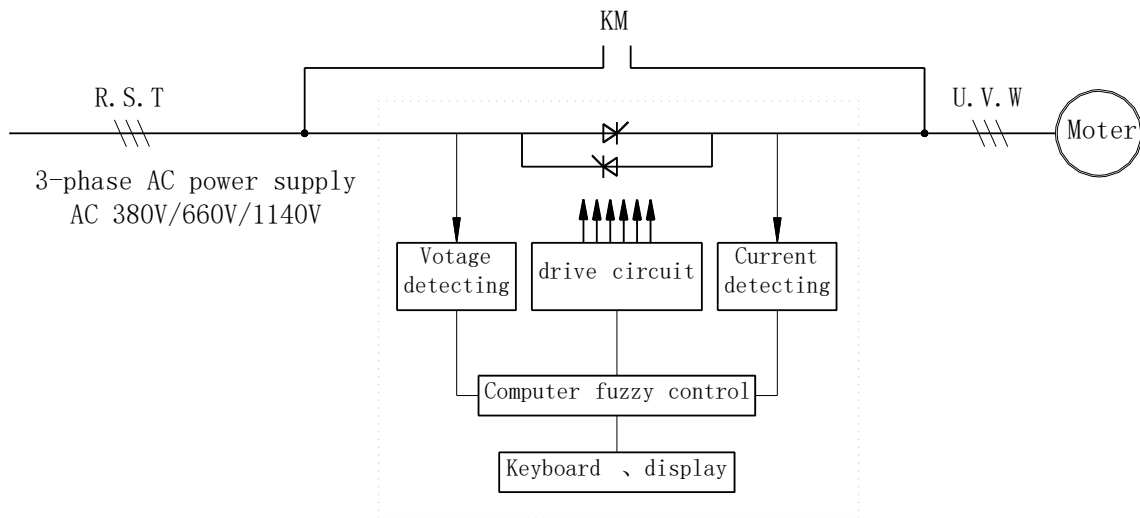

Figure 4-1

5. Wiring and terminal

5.1 Wiring diagram

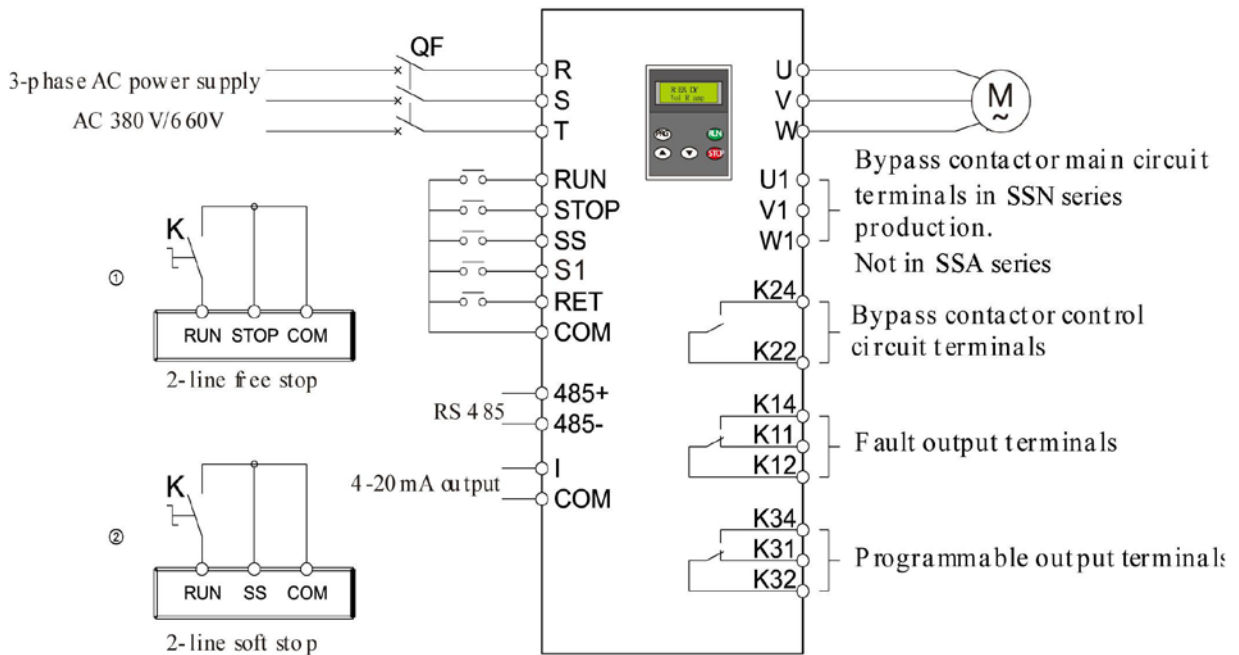
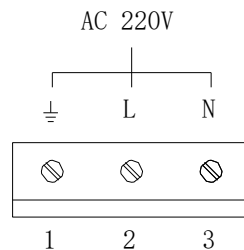

Figure 5-1

Note:

- There are two wiring ways to control starting and stopping the starter externally. They are three-line and two-line wiring. (See ① and ② in the figure above). Start signal is given by connecting terminal RUN and COM. Stop signal is given by disconnecting terminal RUN and COM
Connect according to the figure ①, free stop
Connect according to the figure ②, soft stop
- In the SS-xxA series product, there is no terminals U1, V1, W1. Because there is inner bypass contactor.
- In the SS-xxA series product, the output terminal (K22/K24) are used interior. It is strictly prohibited to external wiring.
- In SS-xxA series product, external control terminals "L" and "N" are added and External AC220V power supply is needed for the product which power is above 90KW.



- SS-xxA series product, there is build-in bypass contactor. No additional bypass contactor.

5.2 External terminals

Table 5-1

Terminal Name		Terminal function		Explanation	
Main circuit	R. S. T	Input		Connect to three-phase power source through breaker (QF)	
	U. V. W	Output		Connect to three-phase asynchronous motor	
	U1. V1. W1	Bypass		See figure F-6	
Control circuit	Digital input	SS	Soft stop	Connect SS and COM directly, Soft stop①	
		RUN	Start	Connect RUN and COM directly, Start①	
		STOP	stop	Connect STOP and COM directly, Stop①	
		S1	jog	Connect JOG and COM directly, jog	
		RET	reset	Connect Reset and COM directly, reset the fault	
		COM	common	Logic Ground	
	Communication	485+	RS485 +	RS485 communication (Modbus communication protocol)	
		485-	RS485 -		
	analog output	I	4-20mA output Load input resistance \leq 400 Ω	$I_m = I_e(I-4)/8$ <div style="border: 1px solid black; padding: 2px; width: fit-content;"> I_m: motor output current (A) I_e: motor rate current (A) I: 4-20mA output current(mA) </div>	
		COM	4~20mA output reference		
	Relay output	K14	NO	Fault output terminals②	In Fault: K14-K12 close ; K11-K12 open Contacts capacity AC:10A/250V DC:10A/30V;
		K11	NC		
		K12	COM		
		K24	NO	Bypass terminals②	Starting end: K24-K22close; Contacts capacity: AC:10A/250V 或 5A/380V DC:10A/30V
		K22	COM		
K34		NO	Programmable terminals② ③	Optional items: starting; running; bypass; fault; soft stopping Contacts capacity: AC:10A/250V 或 5A/380V DC:10A/30V	
K31		NC			
K32	COM				

注①: There are two connecting mode, see figure 5-1

注②: Fault, bypass and programmable output terminals are all dry contact.

注③: In the SS-xxA series product, terminals (K22/K24) are used interior. It is strictly prohibited to external wiring.

5.3 Main circuit wiring

There are six power terminals for SS-xxA series product. R, S, T (Power line) and U, V, W (Motor line). See figure F-5

There are nine power terminals for SS-xxN series product. R, S, T (Power line) and U, V, W (Motor line) and U1, V1, W1 (Bypass line). See figure F-6

5.4 Control circuit terminals

There are control circuit terminals on the main control board. This control circuit terminal provides convenience for the user to realize remote control and external signal control. User can connect the corresponding terminals according to the actual state. By setting the parameter, user can select keyboard mode or terminal mode by to control product to start and stop. There are two row terminals, X1(10 bit) and X2(8 bit), for detail see figure 5-2 below.

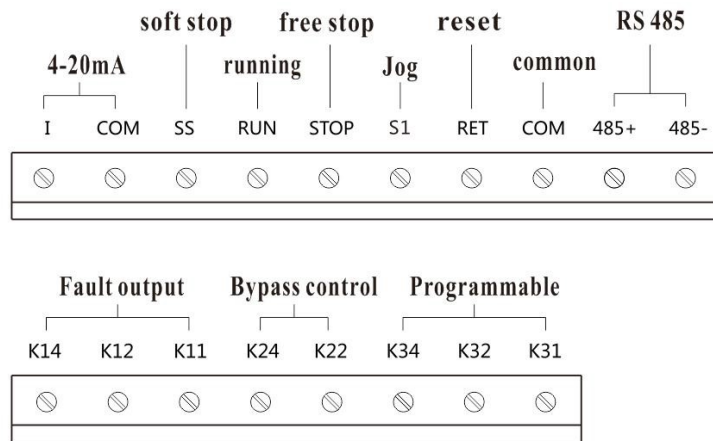
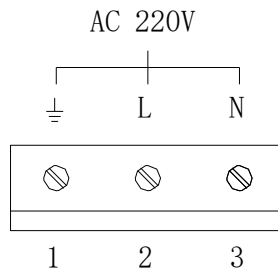

Figure 5-2

Note: In SS-xxA series product, external terminals " L" and " N" are added and external AC220V power supply is needed for the product which power is above 90KW.



6. Control mode

This product has three start modes: Voltage Ramp and Current Limit and jogging. These start modes is independent. Only one of them can be chosen. Text below introduce that the different of them and which mode should be selected.

6.1 Voltage Ramp

The waveform of the voltage shows in Figure 6-1. U_1 in figure is initial output voltage. When starting, the output voltage is up to U_1 immediately, and then ramps up gradually according to the parameter Start Time t setting in advance. Then the motor accelerates continuously. When the output voltage reaches the rate value U_e , the speed of motor reaches the rate speed. Starting process is finished. The Initial Voltage U_1 and the Start Time t can be set according to the load. The range of U_1 is $5\sim 75\%U_e$, and the range of t is $1\sim 200s$.

This mode is used in the state with large inertia load, or in the state in which the current is not the important parameter but the stability is important. Using the mode, the mechanical stress and starting striking may decreased greatly. The bigger the initial voltage is, the more the initial torque and starting striking is. The time of starting is related to the parameter of Starting Time and load. It is unconcerned with current limited. For detail see chapter 8 and chapter 9.

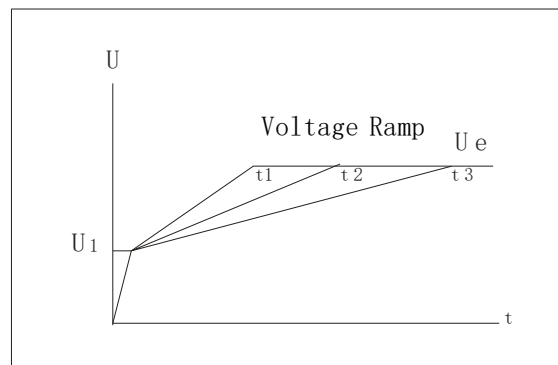

Figure 6-1

6.2 Current Limit

At the Current Limiting mode, the output voltage increases quickly until the output current reaches the limited current value I_m . See figure 6-2. And then the output current maintains below this limited value. Then the output voltage is increased gradually, and the motor accelerate gradually; when the motor's speed is close to the rated, the output current decreases quickly to the rated value I_e , the starting is over. The limited current value can be set according to the load instance. The range of this parameter is $0.2\sim 4I_e$.

This mode is used in the state in which the current is very important parameter. Special in the state in which the grid capacity is small. The parameter of the current limit multiples should be set $2.5\sim 3I_e$. If this value is small, the starting will be abnormal. At this mode, the time of starting is concerned to the parameter of the Current Limit Multiples. The more this value

is, the shorter the time of starting is, Vice versa. For detail see chapter 8 and chapter 9.

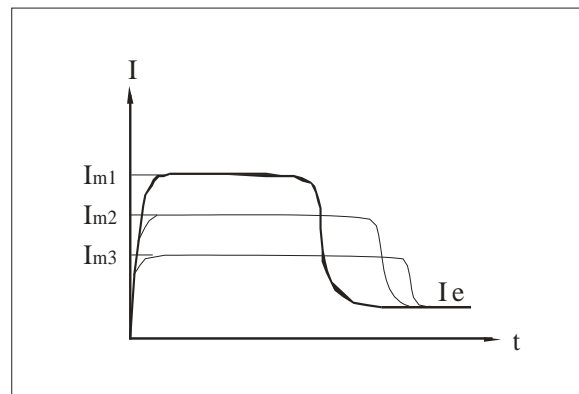

Figure 6-2

6.3 Jogging

At this start mode, the output voltage reaches the initial voltage U_1 quickly, and remains unchanged. Changing the U_1 , the output voltage and torque of the motor will change corresponding. (See figure 6-3). It is convenient to judge the direction of the motor.

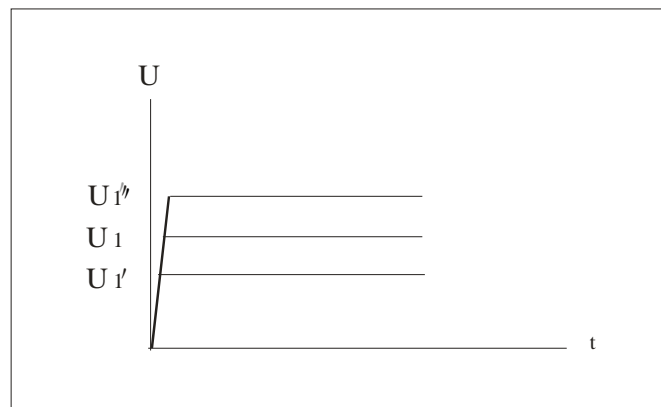

Figure 6-3

6.4 Stop Mode

There are two stop modes. User can set this parameter according to load and working condition.

● Free stop

When receiving the stop signal, the terminals K22, K24 is open, the bypass contactor is disconnected. The trigger signal of the SCR module is close at the same time. Motor inertia stops according the load.

● Soft stop

At this stop mode, when receiving the stop signal, the bypass contactor is disconnected. At the same time, motor is controlled through SCR. The output voltage decreases gradually. At last motor stop completely. The stop time is related to the parameter of load and factor of soft stop time. To gain the smooth stop effect, the Soft Stop Time should be set carefully.

7. Keyboard

7.1 Keyboard Description

There is a Keyboard on the front of the soft starter. User can operate it to display data, save data, check data, display fault, reset fault, start or stop the motor etc. The construction of the keyboard shows in figure 7-1.

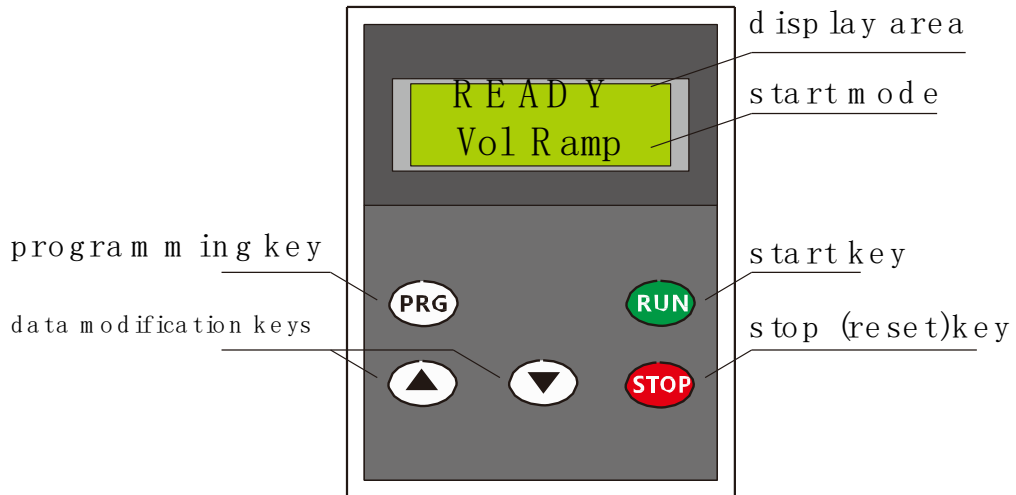

Figure 7-1

7.2 Key Function

There are five key on the keyboard: RUN (start), STOP (stop), PRG (program) ▲ (increase), ▼ (Decrease)

- RUN (start): When the system is in Ready state, press this key to enable the motor start in the start mode which user set.
- STOP (stop) : When the system is in Starting or Running state, press this key, the motor stops, then the system enter Ready state. When the system is on Setting state, press this key, system enter Ready state, and the parameter user modified is saved at the same time. When the system is on Fault state, the fault code shows on the keyboard. Press this key, release it 5 seconds later, system enter Ready state if the fault is deal with.
- PRG(program) : On Ready state, press this key, release it 5 seconds later, system enter Setting state. On Setting state, user can switch between different parameters
- ▲ (increase) : On setting state, user can increase the parameter value by press this key.
- ▼ (decrease) : On setting state, user can decrease the parameter value by press this key.

Note: 1. On Setting state, press PRG key or STOP key, the modified data are saved automatically.

2. If user selects external control, the keyboard can be taken off after all the parameters set.

8. Parameter table

Table 8-1

NO.	Name	Range and mean	default	Remarks		
1	Parameter group	1:base 2:advance 3:communicate 4:Rate current	1			
2	Starting mode	1: Ramp▲ 2: limit★ 3:jog■	1	▲	★	■
3	Initial voltage	5%~75%Ue	30	▲		
4	Jog voltage	5%~75%Ue	30			■
5	Ramp start time	(1~120) S	30	▲		
6	Limit Start Current.	20%~400%Ie	300		★	
7	Limit start time	(1~120) S	30		★	
8	Start protection Current	400%~600%Ie	400	▲	★	■
9	unbalance factor	5%~50% of present current	30	▲	★	■
10	Control Mode	1: keyboard 2: external 3: keyboard and external 4: communicate 5: key and communicate 6: external and communicate 7: all	3	▲	★	■
11	SCR trigger select	1: close trigger 2: not close trigger 3: close trigger, show b-p②	2	▲	★	
12	Start overload level	1~8	4	▲	★	
13	Running protect current	20%~400%Ie	200	▲	★	
14	Stop mode select①	1: free stop 2: soft stop(ramp)	1	▲	★	
15	Soft stop time factor	1~10	5	▲	★	
16	Running overcurrent ON/OFF	1: ON 2: OFF	1			
17	Current unbalance ON/OFF	1: ON 2: OFF	1			
18	Programmable output	0: null 1: starting 2: bypass 3: running4: softstop 5: fault	0			
19	Communicate address	1~256	1			
20	Communicate baud	0: 2400 1: 4800 2: 9600 3: 14400 4: 19200 5: 28800	2			
21	rated current	See chapter9.9 and 10	Motor current			
22	Fault	See chapter12				

Note: ▲: It is valid at Voltage Ramp mode.。

★: It is valid at Current Limit mode.

■: It is valid at Jogging mode 。

①: Parameter “stop mode select” is valid when control mode is keyboard. If the external control mode is selected, stop mode is determined by external line. For detail see figure 5-1.

②: If the parameter “SCR trigger select” is set 3, “b-p” displays in the keyboard, and the product can't monitor the current, and the protection is lost.

9. Parameter setting

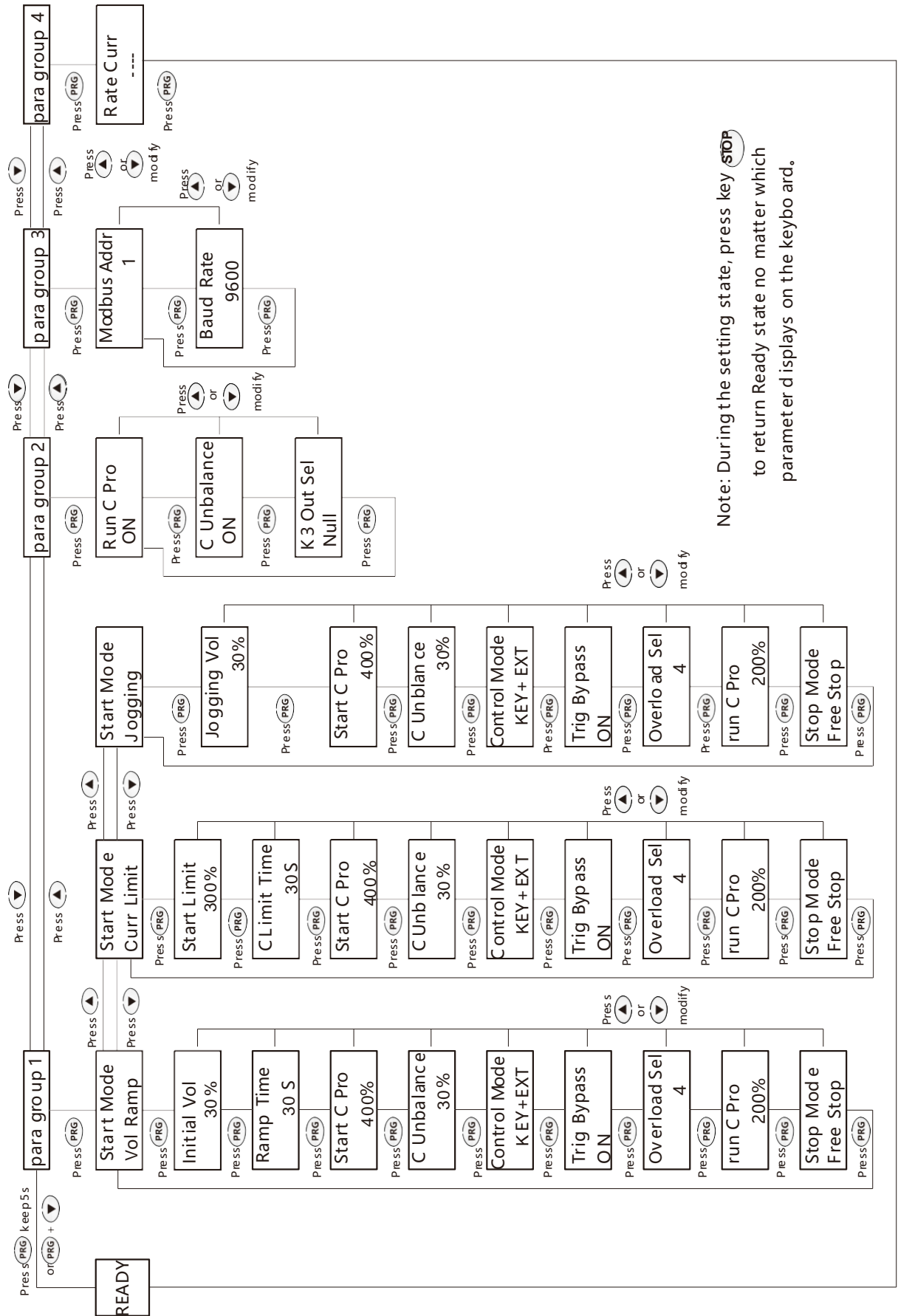

10. Special parameter

● Rate Current

The Rate Current indicate that the output current of the soft starter at the rate power. This parameter changes with the output power of the soft starter. For detail see chapter 9. User can query this parameter by the method shows below.

On READY state, press ▼ key and not release, rate current displays on the keyboard, the unit is ampere. Release this key, system return to READY state.

For Example: rate current is 150A

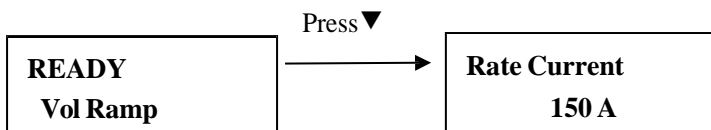

Figure 9-8

● Last Fault

On READY state, press STOP key and release it 5 seconds later, the last fault displays on the keyboard. Release the key, return READY state.

For example: the last fault is missing phase

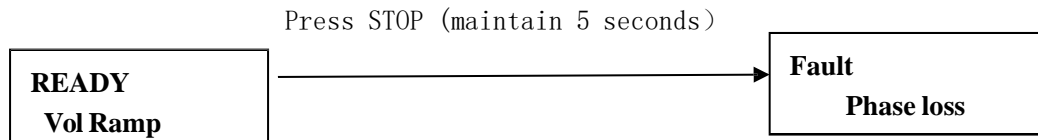

Figure 9-9

11. Displayed Current Calibration

The displayed current of each Soft starter is calibrated before leave factory. If user finds the current value showing on the keyboard is not equal to the actual current value, this parameter can be calibrated again.

WAY1: Set the starting mode to Jogging, and the motor must be connected to its load, the parameter of Jogging Voltage is set below 40%, keep press RUN key (enter the Jogging state), press PRG and up or down key at the same time to modify this value until it is equal to the actual current. Then release the RUN key and PRG key, the modified parameter save automatic. The other way can be adopted when circumstances permit.

WAY2: At the Bypass state, press RUN+▲ key or RUN+▼ key, this parameter can be modified to match to the actual current.

12. Parameter details

Starting Mode	There are 3 starting mode. User can set this parameter by keyboard referring to Chapter 8-1 and chapter 9.
Initial Voltage	<p>This parameter is valid at the Voltage Ramp mode.</p> <p>This parameter indicates that the initial output voltage of the product at the instant of starting and also indicates the initial voltage of the motor (see figure 6-1). The more this parameter is, the more the starting torque is. The default value is 30%. For the fan pump load, this parameter should not set bigger. For the load which has bigger static resistance, this parameter can be increased. This parameter can be adjusted between 20-50%. If the Current Limit mode is selected, this parameter is invalid.</p>
Jogging Voltage	<p>At this mode, the parameter range is 5-75%.</p> <p>At Jogging mode, the output voltage of this product maintains unchanged (it is the set parameter). If this parameter is too low, the motor is unable to rotate. It's normal.</p> <p>User can set this parameter by keyboard referring to chapter 8-1 and chapter 9.4.</p>
Ramp Time	<p>This parameter indicates that the maximum time between the beginning of the starting to the end of the starting. The default is 30s.。</p> <p>If the starting current is not less the 125% of rate current after this time is reached, the soft starter enters the protection state 3s later automatic.</p> <p>This parameter is set according to the load type. For the heavy load and big inertia load type, this value can be increased. For light load type, the starting time may be shorter then the time user set. It is normal if the starting process is all right. This parameter is invalid at the Current Limit mode.</p>
Starting Current Limit	<p>At the Current Limit mode, this parameter indicates the maximum current during starting. The range of this parameter is 20%~400% of I_e. The default is 300%, it means the starting current is the triple of the rate current.</p> <p>For the fan and pump load type, it is all right. For other load type, user can modify it according to the character of load type. It is better to set between 250% and 350%. This parameter is invalid at the Voltage Ramp mode.</p>
Current Limit Time	<p>The range of Limit Time is 1~120 seconds at the Current Limit mode. The default is 30s.</p> <p>In the Current Limit Mode, if the actual starting time is longer than this value, and the starting current is not less than the 125% of the motor rate current, system enter the Protection State.</p>
Start/stop	The range of this parameter is 400~600% I_e . This parameter is set for the protect

Current protect	<p>function aimed at the big current at the starting process. The default value is 400%.</p> <p>This parameter should be increased when the inertial of the load is bigger.</p>
Current unbalance factor	<p>This parameter is set for the protect function aimed at that the difference of 3 phases current is bigger at running. The default value is 30%.The smaller this parameter is, the more the sensitivity is. This parameter should not be too small, in order to avoid the protection is too sensitive to influence the normal operation of the equipment.</p> <p>Note: This protect function is active only when the average current is bigger than the 20% of the rate current</p> <p>The calculation of the current unbalance factor</p> <p>current unbalance factor $\Delta I\% = (I_{max}-I_{min}) / I_{aver}$</p> <p>$I_{aver} = (I_a + I_b + I_c) / 3$</p>
Control Mode	<p>Modifying this parameter, user can change between the keyboard , terminal and PC easily. The default is 1. It means the keyboard control. If it is set 2, it means the terminal control. If it is set 3, it means the terminal control and keyboard control are all available, If it is set 4, communicate, If it is set 5, keyboard and communicate are all available, If it is set 6, terminal and communicate are available, If it is set7, keyboard, terminal and communicate are all available.</p> <p>Note: If it is set 3、 6 or 7, the keyboard and communicate are invalid . if two-line way is used, user can set this parameter by keyboard referring to chapter 8-1 and chapter 9.5.</p>
SCR trigger select	<p>The operation mode of SCR is decided by it after the bypass contactor is closed.</p> <p>1—when the bypass is closed, SCR trigger is blocked. The running current shows on the keyboard and the protection functions are all on.</p> <p>2-- When the bypass is closed, SCR trigger is not blocked. The running current shows on the keyboard and the protection functions are all on.</p> <p>3-- when the bypass is closed, SCR trigger is closed. The running current doesn' t show on the keyboard, and the protection functions are all off.</p> <p>The default value is 2.</p>
Starting overload level	<p>There are 8 levels. The protection time of every level is different. The relation between overload multiples and protection operation time shows in chapter12.2. The default value is 4 (corresponding to IEC60947-4-2 standard 15 class) .</p> <p>Note: The overload protection is inverse time after the bypass contactor is on. It isn' t selected. For detail see chapter 12.2.</p>
running current protection	<p>This protection function will put into work as soon as the instant current is big. The default value is 200%. It means the protection value is twice as the rate current.</p>

Stop mode	There are two stop modes: soft stop and free stop. The default value is 1-free stop. The soft stop function is aimed at “water hammer”. The free stop is set as normal. For detail see chapter 6.4.
Soft stop factor	This parameter is valid only when the stopping mode is free stop. It decide the time and effect of the soft stop. The smooth stop effect will be gained if this parameter is set correct
Running current protect	This parameter control if the running over-current protect is on. 1: ON; 2: OFF
Current unbalance protect	This parameter control if the current unbalance protect is on. 1: ON; 2: OFF
Programmable relay output select	Which state can be output through the programmable relay 0:null, 1:starting, 2:bypass, 3:running, 4:soft stop, 5:fault.
Communicate Address	MODBUS Communicate Address: 1~256
Baud Rate	MODBUS Communicate Baud Rate (0:2400; 1:4800; 2:9600; 3:14400; 4:19200; 5:28800)

13 Working State

● Ready

When the soft starter is power on, self-inspection is performed. The self-inspection includes: test the parameters that the user changed (fault protection of parameters setting), check if the phase of voltage is not right (protection of missing supply phase) and check if the system temperature is too high (protection of overheating) etc. Any fault is detected, the system immediately enter FAULT mode. If no fault is undetected, the system enter the READY state, and the Ready displays on the keyboard panel.

● Setting

When soft starter is in the READY state, presses the PRG button and keep press this button 5 Seconds, or press PRG button and ▼ button at the same time, system enters SETTING state. In this state, user can modify all the parameter. For detail see chapter 9

● Starting

When soft starter is in the READY state, and it is allowed to start the motor, then user can press RUN button to start the motor according to the starting mode user set. At the same time, current value shows on the keyboard. At the process of Starting or running, user can press the STOP button at any time to stop the motor, and then the system enters READY state.

In this state, the system detects the phase of input voltage, over-current (include motor is short, block or over-current), the time of starting and the system temperature etc. So during the motor is running, soft starter can protect motor.

● Bypass

After the starting process completed, the terminals K22, K24 is close automatically. User can control bypass conductor KM by this terminals, then the motor is powered by electric net through the bypass conductor KM. Then the SCR trigger is open or close according to the value of the parameter SCR trigger select shows in table 8-1. The value of current or the character READY shows on the keyboard according to this parameter.

● Fault

When soft starter is on the process of STARTING, OPERATING and READY state, system monitor all the protect parameter. If the value of measured is over the limited value user set, the trigger signal of the SCR module is cut off, system enters the FAULT state. The fault information shows on the keyboard.

14. Fault

There are 11 protections. When the fault is detected, soft starter stop immediately, the fault information displays on the keyboard. User can find the solution by check the explanations to this fault information. After the fault is solved, press the STOP key (keep 3 seconds) or connect terminal RET and COM to reset and return ready state for detail see table 12-1

14.1 Fault displaying and Solution

Table 12-1

information	Fault reason	Solution
para error	Parameter lose	Check the parameter and reset them
lack-phase	Power Line is unconnected A phase output open	Check the power line and output line
motor stall	Current is bigger at starting instant	Check the load Initial voltage is high Current Limit is high
Over heat	heat sink is over heat	If the fan is normal If bypass contactor connect reliable
start T long	Load is too heavy Start time is too short	Check the load Increase the start time Increase the current limit
overload	Is it overload	If the load current exceed the limit
RUN OVER C	Load increase suddenly Fluctuate of the load is too big.	Adjust the load
C unbalance	Motor have fault The parameter of unbalance factor is too small	Check the motor Reset the parameter of unbalance factor
start over C	Current at starting is over the limit	Adjust the limit and protect value
SStop over C	Current at soft stop is over the limit	Adjust the limit of current Adjust the protect of current Adjust the soft stop factor
interference	External interference	Eliminate interference source

Note:

①: The way of inquire of the last error information shows at the chapter 9.7

②: If the fault appears, user can reset the fault by 3 methods showing below.

- Press STOP key and maintain 3 seconds.
- Connect controlled terminals RET and COM, and maintain 3 seconds.
- Shut down the power and power on again.

14.2 Overload

Overload protection function is in used during the process of starting and running

- There are 8 protection levels. The default is 4(same as 15 in IEC60974-4-2 standard). User can set this parameter according to de load situation, the smaller this parameter is, and the shorter the starting time of protection is, vice verse.
- The level 2 cannot be selected(same as 10A in IEC60974-4-2 standard).for detail see the table 12-2 .

Standard curve graph of IEC60974-4-2

Table 12-2

Overload protection levels	IEC60947-4-2	5Ie	4Ie	3Ie	2Ie	1.5Ie	1.2Ie	1.05Ie
1	Class 2	1.5s	2.5s	4.5S	13S	35S	180S	—
2	Class 10A	4s	6S	12S	30S	80S	460S	—
3	Class 10	8s	13S	23S	60S	180S	800S	—
4	Class 15	12s	18S	32S	90S	230S	1200S	—
5	Class 20	16s	25S	46S	130S	320S	1650S	—
6	Class 25	18s	30S	58S	170S	520S	2200S	—
7	Class 30	23s	36S	68S	190S	650S	2800S	—
8	Class Special	28s	45S	82S	224S	—	—	—

IEC609 74-4-2Motor thermal protection curve

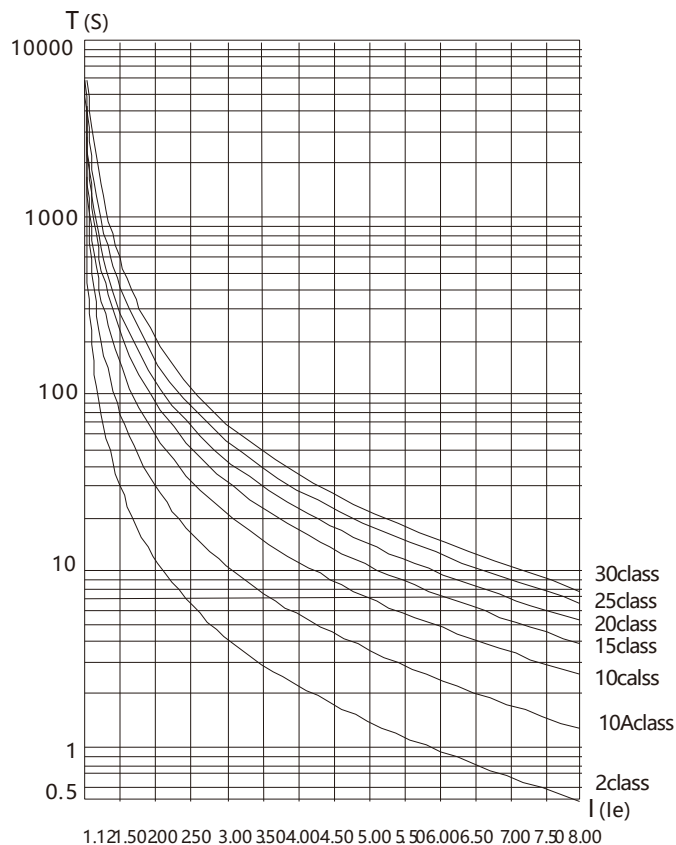

15. Test running

● Inspection before running

For safe running, user should inspection the items show as following items before power on.

- Is the power of the soft starter match to that of the motor?
- Does the insulation of the motor meet the requirement?
- Is the wiring of power and motor line right?
- Do all the nut screw tightly
- Measure the input power (R\S\T) using multimeter, Check whether there is short circuit.

Note: 1. There is linear power transformer between any two phases of power side. Static resistance is about $300\ \Omega$.

2. There are fans between any two phases of load side. Static resistance is about $2K\ \Omega$.

● Power on and trial running

— When power is on, system enter READY state, READY shows on the keyboard means everything is right. There are two lamp on the left of the keyboard to indicate the starting mode (voltage ramp or current limit) . User can select it according to the load.

➤ → If the keyboard display correctly, press RUN key to start the motor, then the actual current displays on the keyboard.

At running state, press STOP key to stop the motor, return to ready state.

— During trial running, if the terminal mode is selected, setting parameter Control Mode according to chapter 8, table 8-1

— If the motor is not connected to the output load terminal U、V、W of the soft starter, step above can also be executed. It is used to check wiring of operate system, bypass contactor, all the lamp etc.

● Attention and Safe

— If any fault is detected, responded fault code will show on the keyboard. See Table 14-1, Please deal with them according to the corresponding tips

— Warning: If the soft starter is power, do not open the shell cover to avoid electric shock.

— Warning: At the course of trial running, any abnormal phenomenon is fond, such as: Abnormal sound, Smoking or abnormal smell, user should cut off the power immediately.

— If the motor is not connected to the output load terminal, power on, voltage can be measured at the output power connections. This is inductive voltage. This is normal phenomenon. This inductive voltage disappears immediately after the motor is connected.

— During trial running, if the starting effect is not ideal, user can modify the parameter such as starting mode, current, voltage and time etc. according Table 8-1.

Appendix 1. Specification and Type

SS-xxN/SS-
xxA/SS-xxN-G

Table F-1

motor power (KW)	AC 380V			
	Rating current (A)	SS-xxN	SS-xxA	SS-xxN-G
7.5	18	SS-008N-3	SS-008A-3	SS-008N-G-3
15	30	SS-015N-3	SS-015A-3	SS-015N-G-3
22	45	SS-022N-3	SS-022A-3	SS-022N-G-3
30	60	SS-030N-3	SS-030A-3	SS-030N-G-3
37	75	SS-037N-3	SS-037A-3	SS-037N-G-3
45	90	SS-045N-3	SS-045A-3	SS-045N-G-3
55	110	SS-055N-3	SS-055A-3	SS-055N-G-3
75	150	SS-075N-3	SS-075A-3	SS-075N-G-3
90	180	SS-090N-3	SS-090A-3	SS-090N-G-3
110	220	SS-110N-3	SS-110A-3	SS-110N-G-3
132	260	SS-132N-3	SS-132A-3	SS-132N-G-3
160	320	SS-160N-3	SS-160A-3	SS-160N-G-3
187	375	SS-187N-3	SS-187A-3	SS-187N-G-3
200	400	SS-200N-3	SS-200A-3	SS-200N-G-3
250	480	SS-250N-3	SS-250A-3	SS-250N-G-3
280	550	SS-280N-3	SS-280A-3	SS-280N-G-3
320	620	SS-320N-3	SS-320A-3	SS-320N-G-3
400	780	SS-400N-3	SS-400A-3	SS-400N-G-3
450	850	SS-450N-3	SS-450A-3	SS-450N-G-3
500	1000	SS-500N-3	SS-500A-3	SS-500N-G-3

Note: SS-xxN-G is the standard cabinet, the circuit diagram show in table F-7

Ordering

- Users should inform the agent the information such as product type, specification, and load when ordering, for ensuring what you ordered is proper.
- The SS-xxN/SS-xxA series product is equipped with a bypass contactor terminals. These terminals is used in bypass up connection (for detail see Appendix 2) , For the users who wish to use below bypass connection mode, please say it to the supplier when ordering.

Appendix 2: SS-xxA series Structure Size (Built-in bypass contactor)

Table F-2

Type	Appearance dimension (mm)			Installation dimension(mm)					Sheet copper dimension(mm)					weight Kg	Installation Method
	W1	H1	D	W2	H2	D1	D2	d	W3	W4	H3	D4	d1		
7.5~30KW	205	295	235	180	270	138	70	Φ7	63	25	289	3	Φ9	10	Wall-suspending figure F-2
37~45KW	230	380	250	160	355	153	71	Φ7	63	25	371	3	Φ9	14	
55~75 KW	260	380	266	180	354	173	97	Φ7	75	25	371	3	Φ9	18	
90~187 KW	265	500	248	220	475	75	42	Φ9	78	35	513	8	Φ11	22	
200~320 KW	300	564	248	260	532	88	55	Φ9	95	40	560	8	Φ13	36	

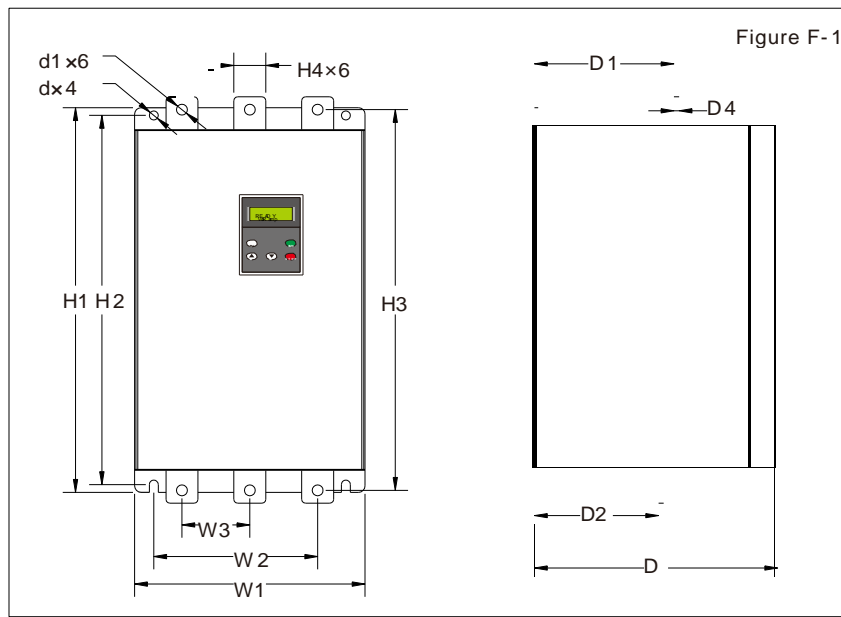

Appendix 3: SS-xxN series Structure Size (bypass up)

Table F-3

Type	Appearance Dimension (mm)			Installation dimension (mm)						Sheet copper dimension (mm)					weight Kg	Installation Method
	W1	H1	D	W2	H2	D1	D2	D3	d	W3	W4	H3 H4	D4	d1		
7.5~30KW	180	240	196	165	224	122	92	125	Φ 5.5	53	15	262 282	3	Φ6	6.5	Wall-suspending figure F-3
37~75KW	180	240	196	165	224	122	92	125	Φ 5.5	53	20	262 282	3	Φ8	7	
90~200KW	274	400	205	230	380	128	73	39	Φ 8.5	78	30	406 426	5	Φ 10.5	20	
250~400KW	304	448	211	270	430	143	89	51	Φ 8.5	87.5	40	456 486	6	Φ 11	24	
450~500KW	472	530	310	400	505	230	55	130	Φ 11	150	40	510	5	Φ 11	45	

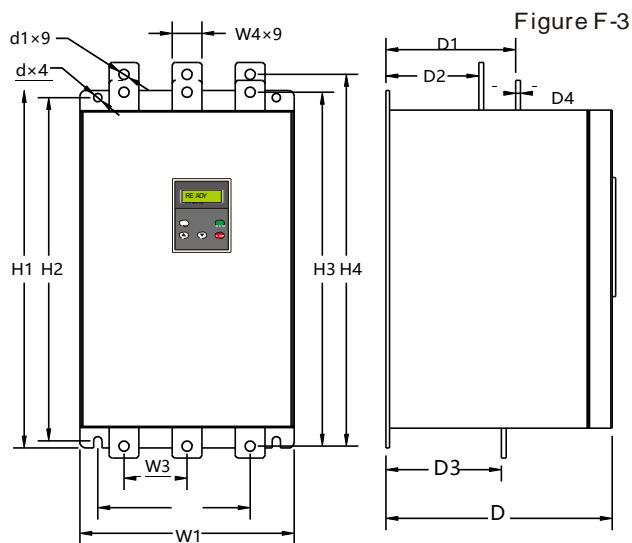
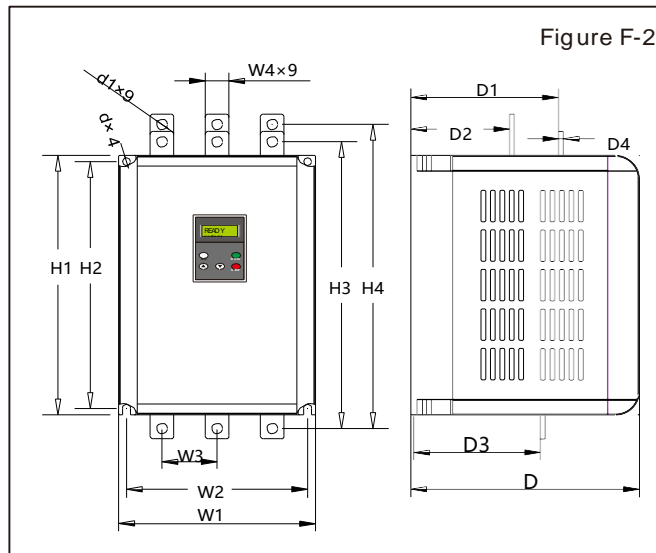

Appendix 4: Keyboard shape and Dimension

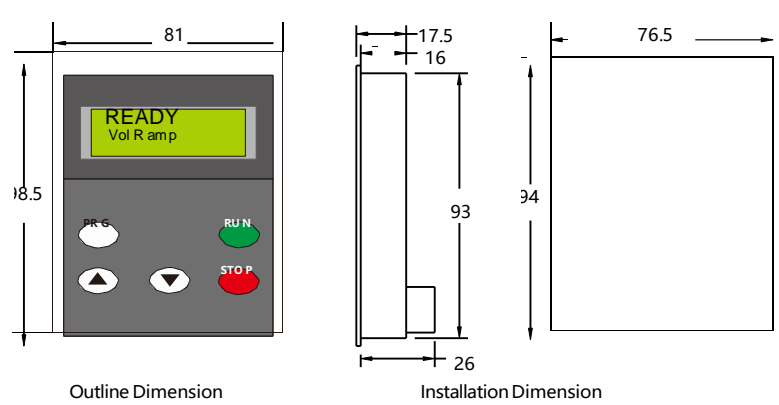

Appendix 5: SS-xxN-G series structure size (bypass up)

Table F-5

Type	Outline Dimension (mm)			Installation Dimension (mm)			Weight Kg	Installation Method
	W1	H1	D	W2	H2	d		
7.5~75KW	560	1800	450	350	240	Φ 11	90	. Cabinet Figure F-7
90~160KW	600	1800	560	390	350	Φ 11	130	
187~400KW	700	2000	600	490	390	Φ 11	180	
450~500KW	800	2000	600	590	390	Φ 11	200	

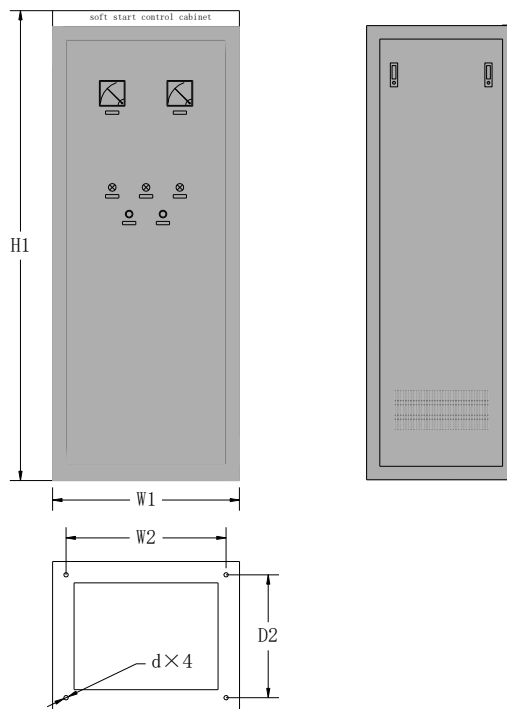
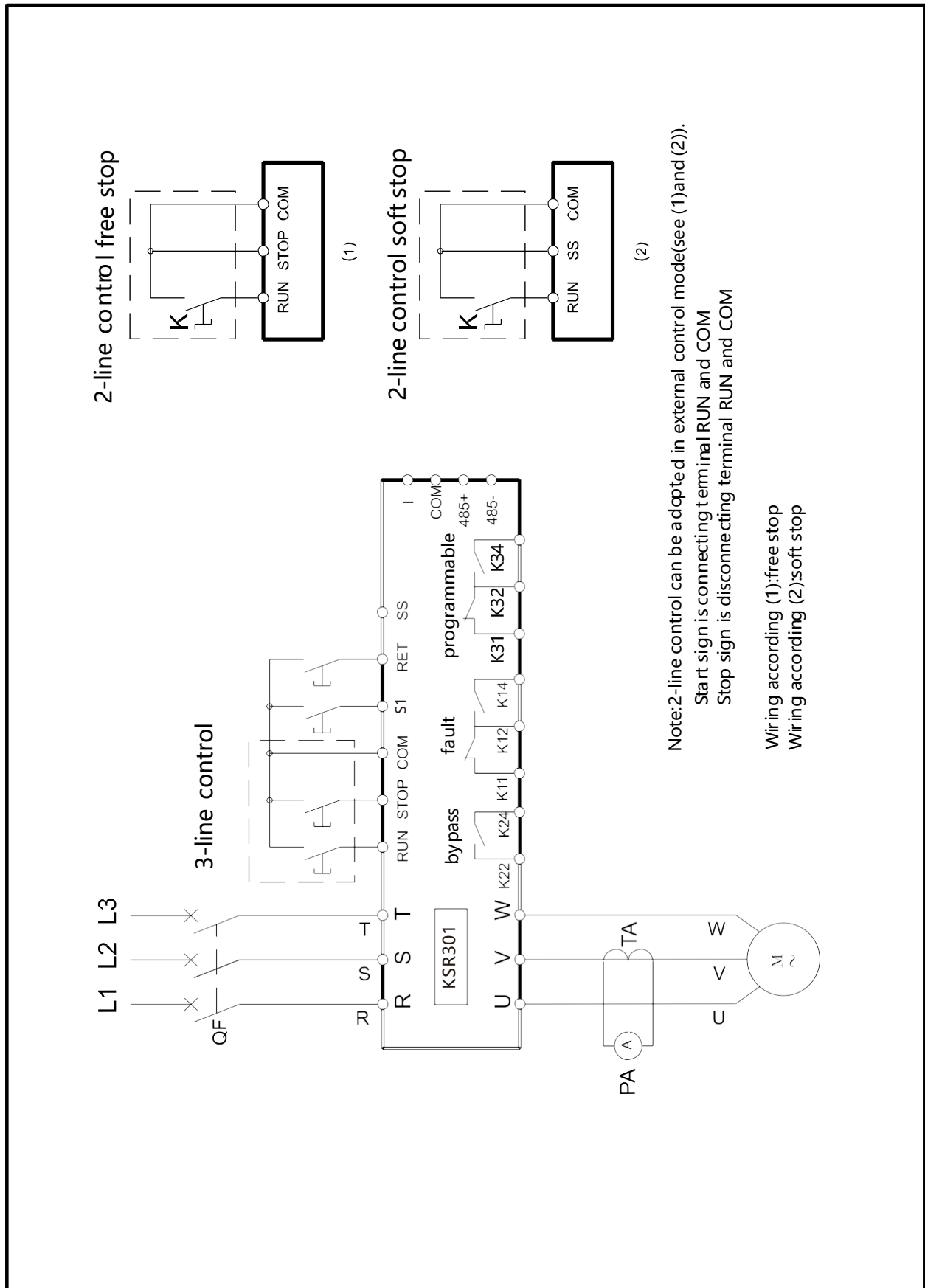
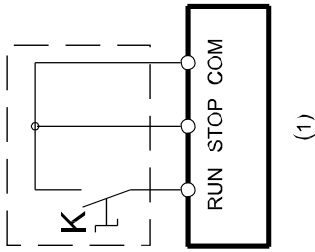

Figure F-7

Appendix 6: SS- series typical wiring diagram



2-line control free stop



2-line control soft stop

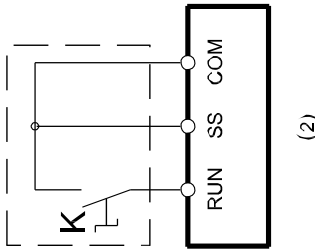

Note: 2-line control can be adopted in external control mode (see (1) and (2)).

Start sign is connecting terminal RUN and COM

Stop sign is disconnecting terminal RUN and COM

Wiring according (1): free stop

Wiring according (2): soft stop

Appendix 7: SS- series typical wiring diagram

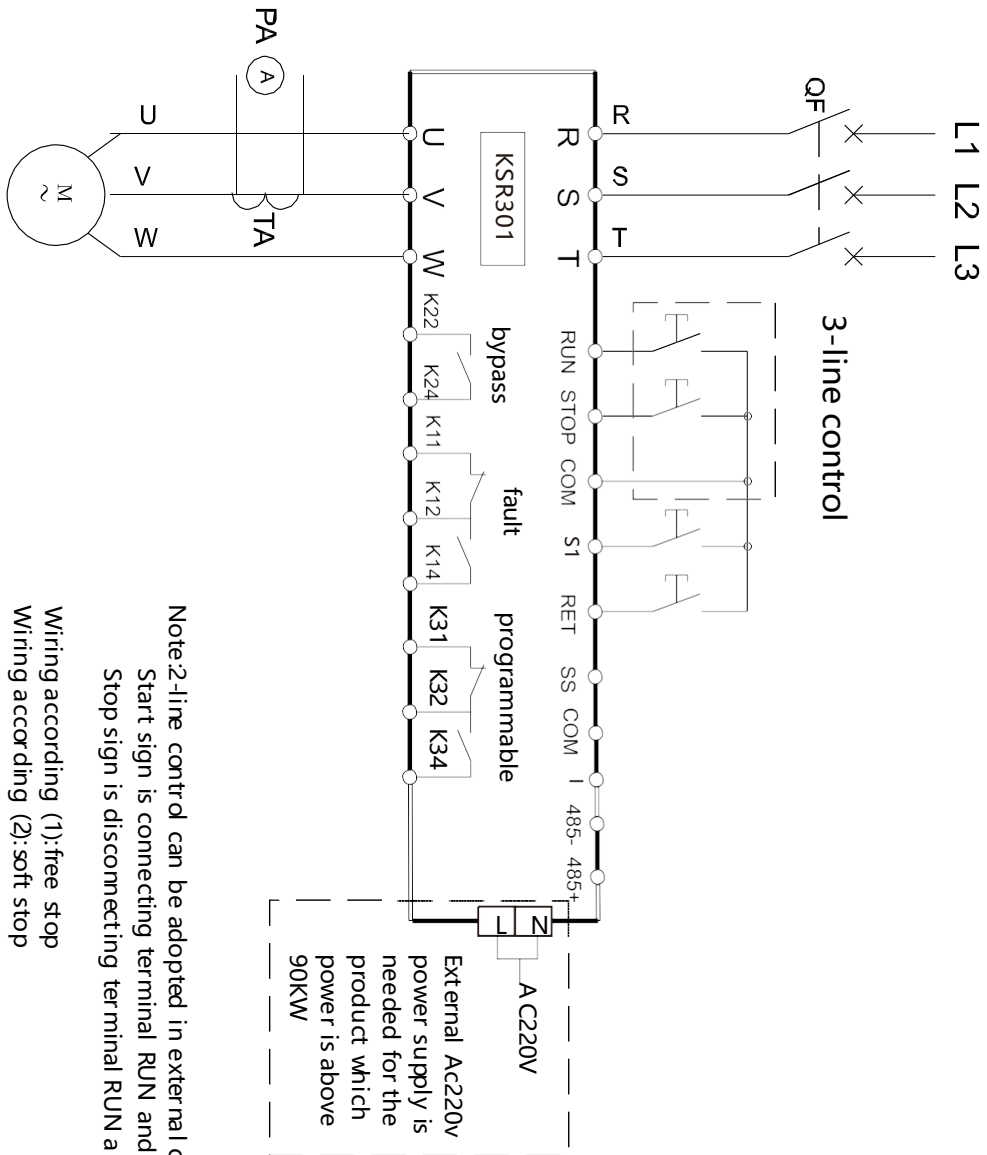

2-line control free stop

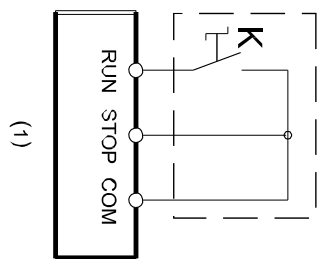

2-line control soft stop

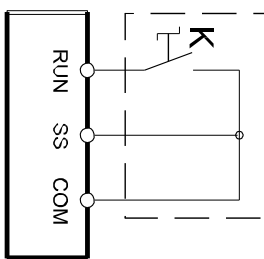

Note: 2-line control can be adopted in external control mode (see (1) and (2)).
 Start sign is connecting terminal RUN and COM
 Stop sign is disconnecting terminal RUN and COM

Wiring according (1): free stop
 Wiring according (2): soft stop