

# Proximity Sensor Hall Effect

## Model:NJK-5002C



### Specifications:

Mounting Way		flush	flush	flush	
Type	N	NO	NJK-5001C	NJK-5002C	NJK-5003C
	P	NC	NJK-5001D	NJK-5002D	NJK-5003D
	N	NO+NC		NJK-5002CD	NJK-5003CD
	P	NO	NJK-5001A	NJK-5002A	NJK-5003A
	N	NC	NJK-5001B	NJK-5002B	NJK-5003B
	P	NO+NC		NJK-5002AB	NJK-5003AB
Sensing Distance		10mm±10%	10mm±10%	10mm±10%	
Setting Distance		0-8mm	0-8mm	0-8mm	
Standard Detection		∅8*2mm Magnetic iron	∅12*2mm Magnetic iron	∅18*2mm Magnetic iron	
Response Frequency		1kHz	1kHz	1kHz	

### Chart:

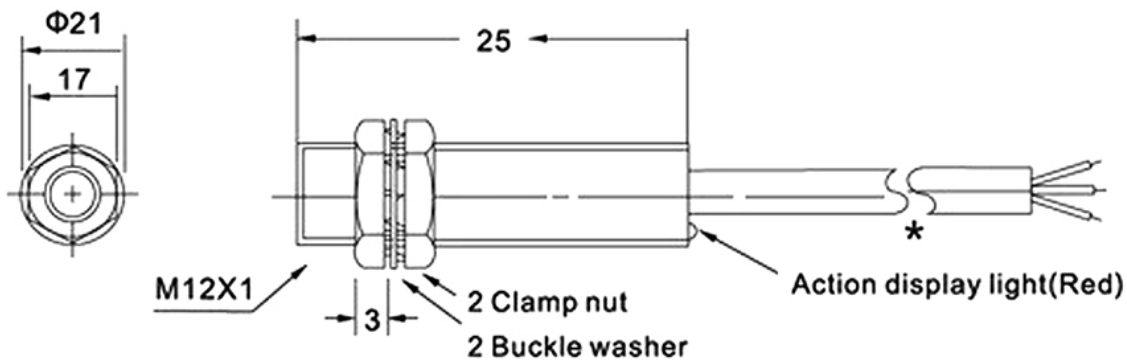

**Wiring Diagram:**

**1.DC 3-wire NPN models NO or NC**

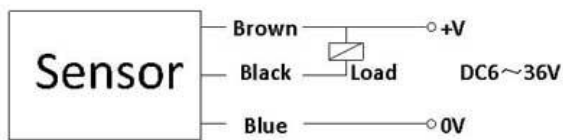

**2.DC 3-wire PNP models NO or NC**

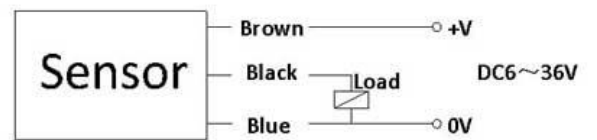

**3.DC 2-wire models NO or NC**

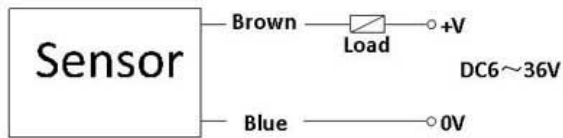

**4.AC 2-wire models NO or NC**

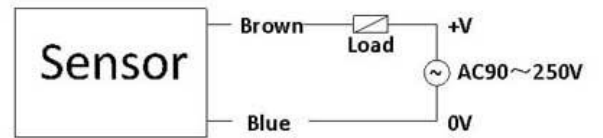

**5.DC 4-wire NPN models NO + NC**

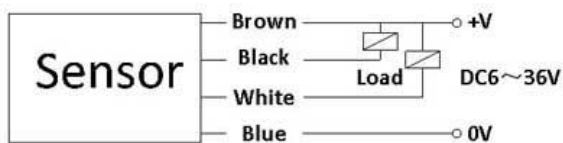

**6.DC 4-wire PNP models NO + NC**

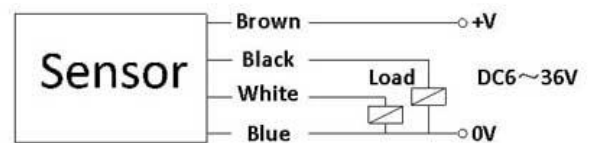

**7.AC/DC 5-wire(relay output) NO+NC**

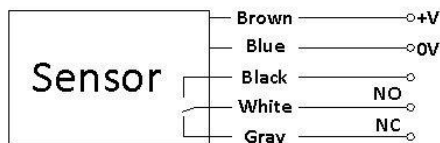

*Made in China*